



DDWH10

Thermo-Clean® Technology

DDW-100001

DESICCANT DEHUMIDIFIER/HEATER

Wall Hung/Free Standing with Heating

IP24 Rated

USER MANUAL

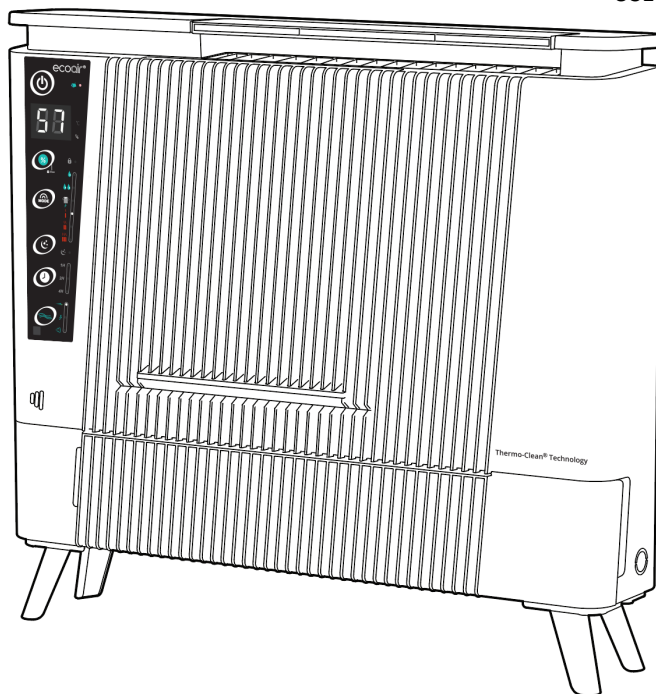

DISPOSAL



The appliance must not be disposed of with household waste, but taken to an authorised waste separation and recycling centre.

Please read instructions before use.
Keep for future reference.

Visit ecoair.org to register your product or terms and conditions.

WELCOME

Thank you and congratulations for choosing an EcoAir dehumidifier to help you improve the air quality within your environment. Inside you will find many helpful tips on how to use and maintain your dehumidifier efficiently. Just a little preventative care can save you money and prolong the life of your dehumidifier.

The purpose of the dehumidifier is to remove the excess moisture in the air by detecting the humidity level in the room. By keeping humidity within recommended levels, a dehumidifier combats household damp, mould and mildew. Dehumidifiers can help to reduce the symptoms of asthma, allergies, and other respiratory health conditions. They can also be used to help dry laundry quicker and control moisture-based damage (such as the aftermath of flooding, leaks or rising damp) to valuable belongings and furniture.

HUMIDITY GUIDE

There will always be water vapour in the air. The water vapour (or commonly known as moisture) in the air is measured in Relative Humidity (RH) %. RH is the ratio of the actual amount of water vapour in the air to the amount it could hold when saturated expressed as a percentage. Too much or too little moisture in our homes can be unhealthy and uncomfortable. The optimum humidity level is between 40% and 60% (RH) where we feel most comfortable.

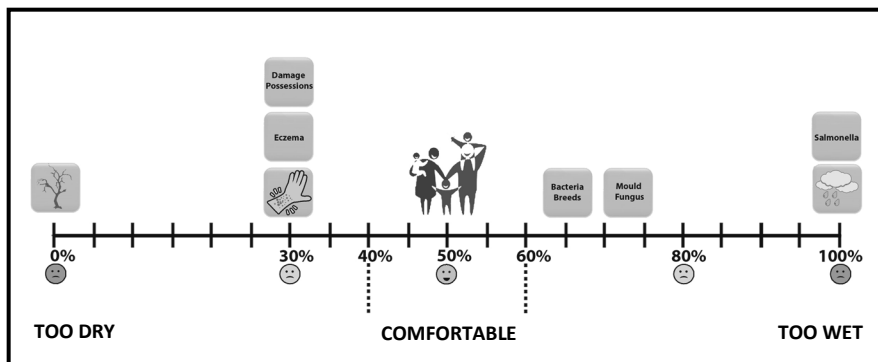

Low humidity

Low humidity indoors causes excess drying which can trigger skin irritations such as eczema, chapped skin and dry nose. It can also damage possessions, such as wooden furniture, musical instruments and artwork by drying it out too much.

High humidity

High humidity indoors causes damp and condensation. The damp left by condensation can damage plaster, wall paper, furniture, vehicles, timber windows, doors and clothes. It can be harmful to our health when bacteria thrives, causing mould and fungus.

Maintaining safe levels of humidity

It is important to maintain a consistent humidity range to preserve furniture, paintings, door and window frames. High humidity causes swelling, corrosion, softening of glues and paint. Low humidity causes shrinking, cracking, warping of wood surfaces and gaps in joints, doors and windows. Frequent changes in humidity levels can accelerate damages to property and belongings.

Condensation

The warmer the air, the more moisture the air can hold than colder air. So, when the air inside the house becomes colder, the moisture contents in the air becomes saturated, and gets heavier resulting in moisture concentration on the coldest parts of the house particularly on the windows, bathroom mirrors and walls. This is condensation, caused by a sudden increase in humidity, cooking, showers, drying clothes, inadequate ventilation and poor thermal insulation.

Condensation does not disappear instantly even with the dehumidifier on. Where excessive condensation appears for example, on your windows, you may want to open your windows to expel the excess humidity for several minutes. It will take a while for the condensation to generally increase the humidity in the room. Once the humidity level in the room around the dehumidifier is increased above the level you have set on the dehumidifier, it will then begin the dehumidification process.

INDEX

Important Safety Instructions	1
The Appliance and Accessories	2
Important Safeguards	3
Installation	4
Setup Continuous Drainage	5
Setup Wall Mount	6
Control Panel	7
Operation	8 - 9
Emptying The Water Tank	10
Remote Control	11
Dehumidifier Legs	12
Cleaning, Maintenance and Storing the appliance	13
Troubleshooting	14 - 15

IMPORTANT SAFETY INSTRUCTIONS

WARNING!







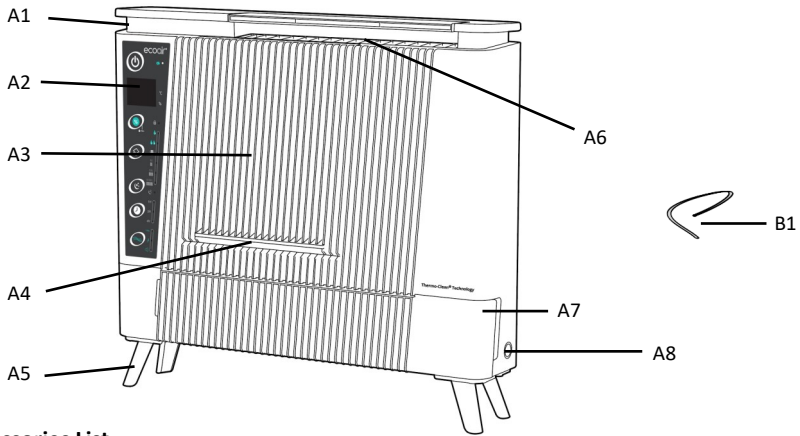

This dehumidifier is intended for use in domestic households and similar working and residential environments and is not intended for outdoor use. It must be used only as a domestic appliance. EcoAir cannot be held liable for damage resulting from incorrect or improper use or operation

- Do not alter or modify the appliance's characteristics in any way. Should repairs be necessary, contact EcoAir's Authorised Service Centre. Self-servicing or unauthorised servicing can be dangerous.
- The appliance must be installed in accordance with the relevant national legislation.
- The appliance is not intended for use by persons (including children) with reduced physical, sensory or mental capabilities, or lack of experience and knowledge, unless they have been given supervision or instruction concerning the use of the appliance by a person responsible for their safety.
- Children and pets should be supervised to ensure they do not play with the appliance.
- Do not use the appliance if the power cable, cord is damaged. It must be replaced by an EcoAir's Authorised Service Centre.
- The appliance must always be placed in an upright position on an even level surface to avoid any damage, during use or transportation and when put into storage.
- The appliance must be plugged into a grounded 3-prong outlet and ensure that the voltage matches the rated specifications. If in doubt, check with a qualified technician.
- Do not use with extension cables or multi sockets. Do not pull or place strain on the power cord when moving appliance.
- Always unplug the appliance before cleaning or maintenance or when not in use.
- The appliance must not be placed or used where the atmosphere may contain combustible gasses, oil or sulphur or solvent, or near heat sources (such as heaters or in server rooms) or excessive dust.
- Do not place or rest any objects on the appliance and do not cover while in use. Always observe the minimum room size for storing and operating the appliance.
- If mounted on a wall, the wall should be level and the unit level on the wall.
- If used in the bathroom, wet rooms or shower room, please follow your local building regulation and refer to (page 6)
- IP24 fitting in bathrooms or wet rooms please refer to website for Rating and Zones.
- Filter must be cleaned every 2 weeks to avoid dust building up internally causing overheating and malfunction.
- To protect against electric shocks, do not immerse or spray the appliance or any of its parts in water.
- Ensure the air inlet and outlet are not blocked or covered when in use.
- Do not insert fingers or any objects into the air inlet or outlet openings.
- Do not operate or store the appliance under direct sunlight.
- Always switch off the power before unplugging from the socket.
- Do not leave the appliance running or plugged in over a long period of time unattended. Leaving unattended electrical appliances running is unsafe.
- Always make sure your hands are dry when operating the appliance.
- Only operate the appliance within the specified operating temperature range.
- Do not run power cord under carpeting, or cover with rugs or runners. Arrange the cord away from areas where it may become a trip hazard.
- Always ensure the laundry is placed a safe distance from the dehumidifier at least 40cm.
- Always clean the filter and cover the dehumidifier with a dust sheet when storing the dehumidifier.

THE APPLIANCE & ACCESSORIES



Accessories List

						
B1	B2	B3	B4	B5	B6	B7
						
B8	B9					

DESCRIPTION

Key	Description	Key	Description	Key	Optional Parts
A1	Grip Handle	B1	Continuous Drainage Hose	C1	Carbon Filter (Sold separately)
A2	Control Panel	B2	User Manual		
A3	Air Inlet	B3	Wall Mount Bracket x 1		
A4	Filter	B4	Silicone Spacer x 2		
A5	Dehumidifier Legs	B5	Raw Plugs x 2		
A6	Air Outlet	B6	Long Screw x 2		
A7	Water Tank	B7	Short Screw x 2		
A8	Knockout x 2 (Left + Right)	B8	Elbow		
		B9	Remote Control		

IMPORTANT SAFEGUARDS

WHERE TO POSITION YOUR DEHUMIDIFIER?

Ensure the unit is a safe distance away from furniture, direct sunlight or any other objects close by.

TIP: Position the dehumidifier in the dampest room or somewhere central like a landing or a hallway. As long as the internal doors are open the excess moisture from all of the rooms in the house will migrate naturally towards the dehumidifier and be processed.

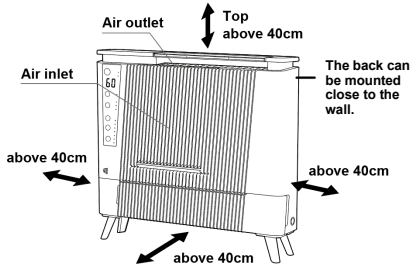

DO NOT PLACE OBJECTS ON OR OVER THE APPLIANCE

Ensure the air inlet (A3) and air outlet (A6) are not obstructed. Obstruction will cause overheating and malfunction.

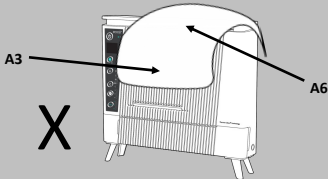

DRYING YOUR LAUNDRY

Never place wet laundry over the appliance. Dry the laundry on a rack with a minimum distance of 40 cm.

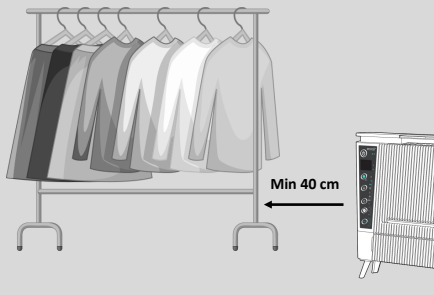

ROOM SIZE



- Never use in small confined area. (Broom cupboard, boiler room, unventilated rooms, in close proximity to a heat source such as heater, tumble dryer, cooker).

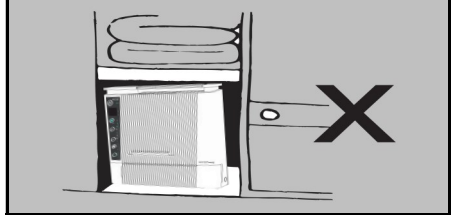

DO NOT SPLASH

- Do not wash the appliance or immerse in water
- Do not allow water to drip on to the appliance

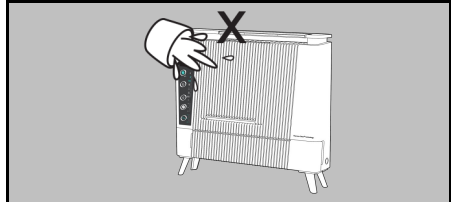

PLACE ON EVEN LEVEL FLOOR

- Always operate appliance on an even level floor to avoid leakage
- If appliance is on carpet, ensure the appliance is stable and level

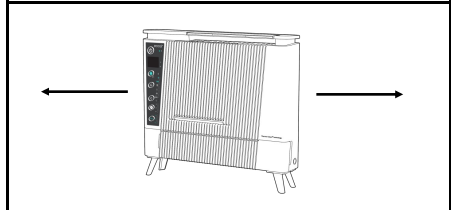

IMPORTANT

- Do not move the appliance or remove the water tank when the dehumidifier is running. It may cause damage, electric shock, water leak or spills.
- After turning the dehumidifier off, do not remove the power plug from the power socket immediately, allow the appliance to cool down for a minimum 5 minutes to help protect the internal components.
- Dusty, building sites or an industrial environment where particles can clog up the filter or internal components.

INSTALLATION

PLEASE READ IMPORTANT SAFEGUARDS BEFORE INSTALLATION

FIND A SUITABLE POSITION

- Position the dehumidifier in the dampest room or somewhere central like a landing or a hallway. As long as the internal doors are open, the excess moisture from all of the room in the house will migrate naturally towards the dehumidifier and be processed.
- If there is a problematic area or a room in a high humidity level, use a hygrometer to measure (available to purchase at ecoair.org) in the property, you may wish to place it in that area initially. Once the problem is settled you may wish to relocate to the location above.
- Please refer to the important safeguards on the previous pages when positioning the dehumidifier, such as a safe distance away from the wall, avoid confined areas, ensure floor is even and level surface.

INSTALLING THE DEHUMIDIFIER

- Unpack the dehumidifier and plug in to the socket.
- If mounted on a wall, the wall should be level and the unit level with the wall.
- If used in the bathroom, wet rooms or shower room, please follow your local building regulation and refer to (page 6).
- IP24 - Please refer to website for Rating + Zones.
- Check that the dehumidifier is level to avoid any water leaks or drainage issues.

ZEOLITE

- When you first use the dehumidifier and periodically thereafter you may notice a smell coming from the dehumidifier. This is caused by the Zeolite desiccant material and is NOT a sign that the dehumidifier is faulty, nor is it harmful to humans or pets.
- The Zeolite absorbs odours from items such as cigarettes, cosmetics, hair sprays, building materials and new furniture and then when the desiccant is heated the smell is discharged into the room. (This smell has been described as being like a burning smell or a sour smell). This is normal and will NOT last long, nor is it a sign of a fault.

INITIAL OPERATION

- When you first use your dehumidifier it will work hard to reduce the room humidity to your set target humidity. This is the time when it will produce most of the water and need emptying more frequently. As the room become dryer, the dehumidifier collects less water. This is normal.
- Once the power is restored after a power failure, the dehumidifier will continue to operate at the selected settings prior to the power failure.
- After turn-off, the fan will continue to run for two minutes to help cooling and protecting the internal component.

SETUP CONTINUOUS DRAINAGE

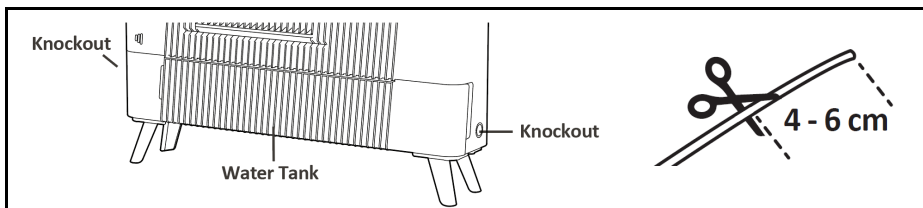

STEP 1

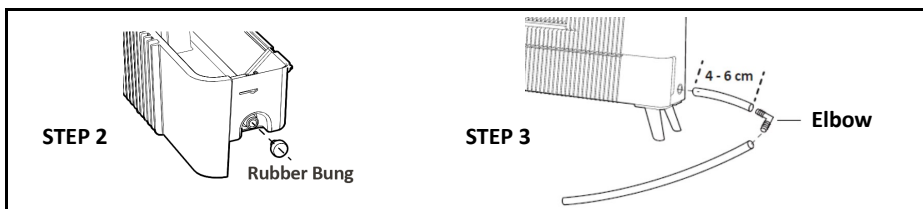





Use a hose with an inner diameter of 12mm for continuous drainage:

1. Use a screwdriver to remove the knockout at the side (right or left) of the unit **(A8)**.
2. Remove the water tank **(A7)**.
3. Remove the rubber bung from the drain hole at the side (right or left) of the water tank (keep rubber bung for future use).
4. Reinsert water tank **(A7)** in the correct position.
5. Firmly attach the 4 to 6 cm hose to the drainage fitting through the hole (right or left). Fit the longer hose firmly on the elbow. (Note: The water tank must be in the correct position for running).
6. Push and connect the hose firmly to the drain hole of the water tank.
7. Once the hose is securely attached, lead the other end of the hose to an appropriate drain at a downward slope with no sharp bends.

NOTE:

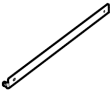
- When using the dehumidifier with a continuous hose attached, never pull out the tank. This may cause water leakage or damage to the open tap. If you need to remove the water tank, ensure that the hose is disconnected first.
- Never leave the end of continuous drainage hose outside when the temperature is below 1°C to avoid leakage. (When the outdoor temperature is at freezing point the water will not flow freely and this will cause a blockage consequently pushing the any condensation back to the dehumidifier and leakage may occur).
- Ensure to open end of the drainage hose cannot be submerged in the water as it will cause back pressure, water will back up into the tank. Best practice is to use an open drain.

SETUP WALL MOUNT (if needed)

Accessories			
Item	Quantity	Schematic	Application
Wall mount bracket	1		For attaching to the wall to support hanging the machine.
Silicone spacer	2		Use short screws to screw to the back of the machine.
Raw plugs	2		Inserted into the wall for securing the wall mount bracket. Drill bit 4mm - 5mm.
Long screw	2		Securing the wall-mount bracket.
Short screw	2		Securing the silicone spacers.

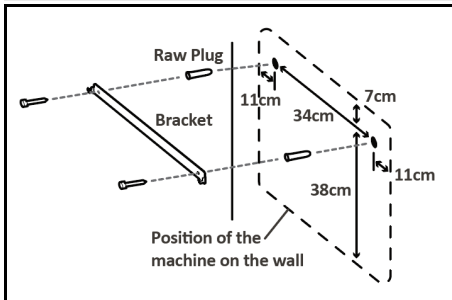

1. Position the two holes on the wall for fixing the bracket horizontally. Please refer to the drawing of the relative positions among the holes and the machine.
2. Drill the two holes in the wall and insert raw plugs.
3. Use long screws to fix the bracket on the wall.

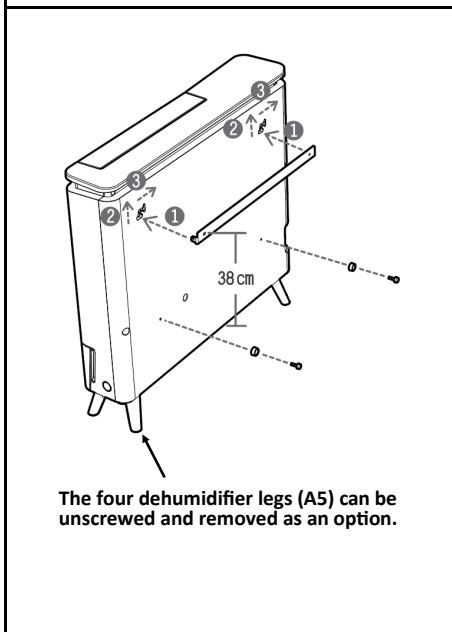

4. Use short screws to fix the silicone spacers on back of the dehumidifier.
5. To hang the machine onto the bracket hooks via two L-shaped slots. Follow the illustrated 3 steps and ensure the machine is securely fixed in place.
6. Ensure the dehumidifier is level on the wall, use a spirit level.

IMPORTANT

When installing in a bathroom or toilet, the plug must be replaced with a fused connection unit (Spur) and the connection made by ELECTRICAL SPUR. This must be performed by a qualified electrician to avoid personal injury.





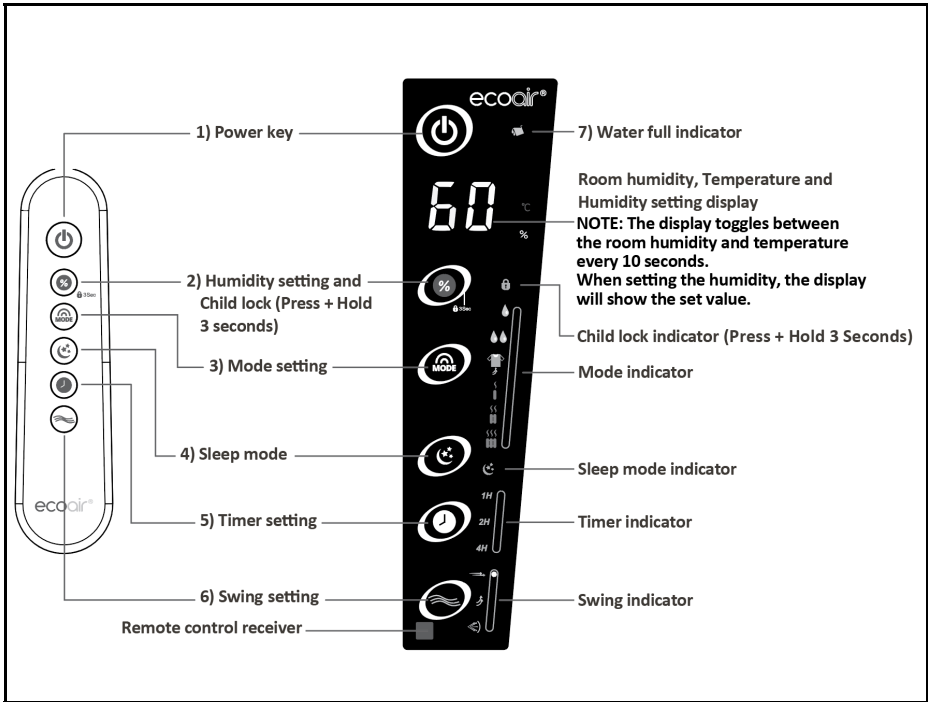





CONTROL PANEL





- 1) **Power Key** - Turn unit on **ON/OFF**.
- 2) **Humidity Setting** - To adjust humidity level. Select **LOW** or **HI** settings.
- 3) **Mode Setting** - Select **DEHUMIDIFYING**, **LAUNDRY** or **HEATING** settings.
- 4) **Sleep Mode** - To turn **Sleep Mode** on/off.
- 5) **Timer Setting** - To turn on **Timer**
- 6) **Swing Setting** - To select 3 swing mode
- 7) **Water full Indicator** - Indicator lights up when the water tank is full or incorrectly installed.

OPERATION

POWER KEY - ON/OFF 	
TO OPERATE UNIT	<ul style="list-style-type: none"> Place the unit in an upright position and on even level surface. Plug the unit into the mains socket. Press the ON/OFF button to operate the unit. Now select Mode. To switch the unit OFF, Press the ON/OFF button. Note the fan will run for 2 minutes, to help cool and protect the internal components. (TIP: do not unplug the power socket until the fan stops)

MODE SETTING 	
<p>Press the mode button to select modes in the following loop:</p> 	
	⇒ Select the ECO dehumidification mode, where the machine operates with a low power.
	⇒ Select the standard dehumidification mode, where the machine operates with a medium power.
	⇒ In LAUNDRY, the Humidity Settings and Fan Setting is disabled, the machine operates continuously. When you press the Humidity Setting button, the display will show “CO “. Please see Note Below.
	⇒ ECO Heater mode, where the machine operates with a low PTC and low fan. (LCD will show “H1”)
	⇒ MID Heater mode, where the machine operates with a mid PTC and mid fan. (LCD will show “H2”)
	⇒ HIGH Heater mode, where the machine operates with a high PTC and high fan. (LCD will show “H3”)
<p>Note: In Heater mode, humidity cannot be set. When the ambient temperature reaches 30°C, the PTC heater will shut down for safety reasons. It will automatically restart once the ambient temperature drops.</p> <p>Note: If ambient humidity drops to 35% or lower, it will stop collecting water; the fan will continue to run for 2 minutes before shutting off. It will resume automatically when humidity rises above 35%.</p>	

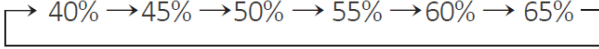
HUMIDITY SETTING 	
<p>Press the humidity setting button to select your target humidity:</p> <p>Note: You can only set the humidity in  and  mode</p> <ul style="list-style-type: none"> Press the humidity button to change humidity to 40% to 65% at 5% intervals.  <ul style="list-style-type: none"> The humidity display will switch to the actual ambient humidity after 5 seconds. <p>Note: You cannot set humidity on laundry mode.</p>	

OPERATION

CHILD LOCK



- Press down the Humidity button for 3 seconds to set up or release a Child lock mode.
- When in child locked, all buttons are disabled except POWER button and the  LED light will be on.

SLEEP (DIMMED) MODE



- Press the Sleep button mode to set up or release a Sleep mode.
- All LEDs are half-lit. All buttons are muted except the power button.
- If the dehumidifier is left idle for 3 seconds, only the night mode indicator stays dimly lit, and other lights and the digital display turn off. Any button press will wake up the device, and it can be operated thereafter.

TIMER SETTING



- Power on the dehumidifier, press the timer key to set “timer” mode. The timer will automatically set to 1H.
- Press the timer again to select 2, 3,4,5,6,7-hour settings.
- **Off Timer Setting:** After setting, the indicator light will display the remaining time along with the timer; for example, if 4 hours is selected, when the running time is gradually reduced, the indicator light will switch to 3, 2 and 1 hours till it stops.
- When the timing is not set (the lights are all off), the unit will run continuously.

→ 1hr → 2hr → 3hr → 4hr → 5hr → 6hr → 7hr → Continuous (no led) →

SWING SETTING



- Press the SWING button to select the louvre swing ranges in the following loop:

→ FRONT → → UP ↗ → WIDE ⇐ → Stop (no led) →

EMPTYING THE WATER TANK

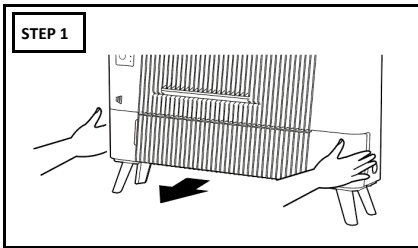

Remove water tank

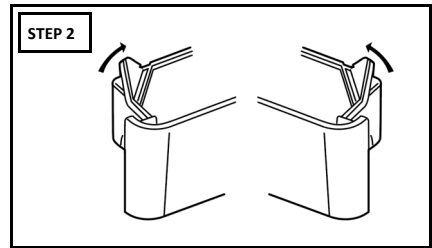

Lift the right corner of the water tank gently

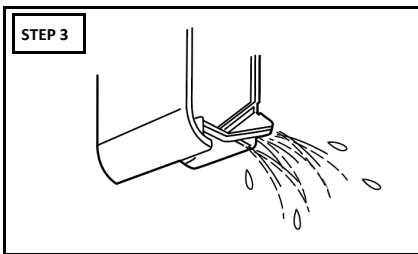

Empty the water tank

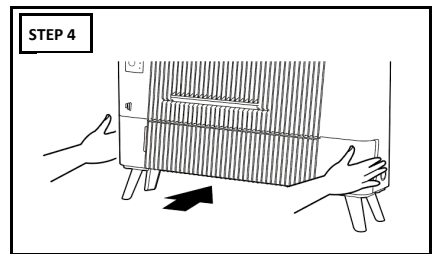

Restore the water tank

The Water Full lights up when the water tank is full. The appliance will stop operating. Allow to stand for approximately 30 minutes to ensure all water collected drips into the water tank.

1. Gently pull the water tank out. Wipe dry the internal compartment
2. Lift the right or left corner of the water tank gently.
3. Pour the water away, lift off splash lid and clean the water tank if needed.
4. Insert the water tank back into to the correct position. (The Water Full light indicator illuminates if the water tank is not correctly in position. If this happens, reinsert again).

NOTE :

- Clean the water tank with mild detergent if necessary. Do not use solvent, abrasive or hot water.
- When cleaning the water tank, take caution to avoid damaging the float.
- Do not tilt the dehumidifier when removing the water tank. This is to prevent water leaking which may cause electric shock.

REMOTE CONTROL

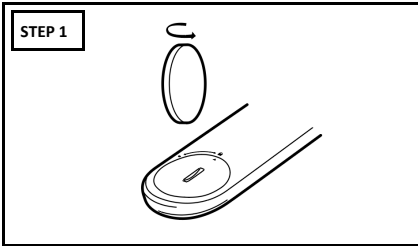

Counterclockwise to open the battery cover

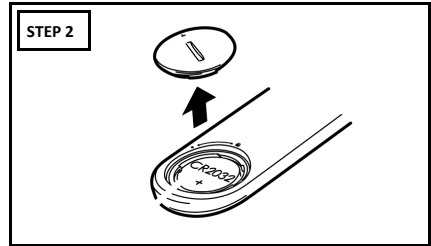

Battery (+) face up

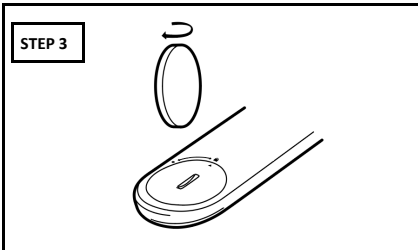

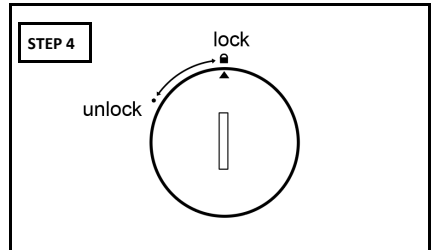

Clockwise to secure it in place



1. A button cell (CR2032) is included inside. Please remove the insulation film before use.
2. To replace the battery, use a coin to fit into the middle slot of the cover turn counterclockwise to the indicated position to open the battery cover.
3. Insert the batteries into the compartment, following the polarity markings (+ and -) inside.
4. Place the battery cover back and turn it clockwise to secure it in place.

Remote control holder

Accessories		
Item	Quantity	Schematic
Raw plugs	2	
Long screw	2	

Drill two holes in the wall and insert expansion bolt.
Use long screws to fix the holder on the wall.

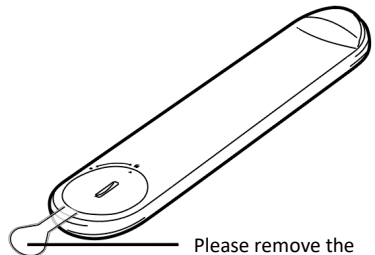
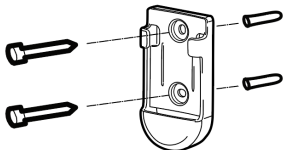

Please remove the insulation film before use.

LEG STAND INSTALLATION

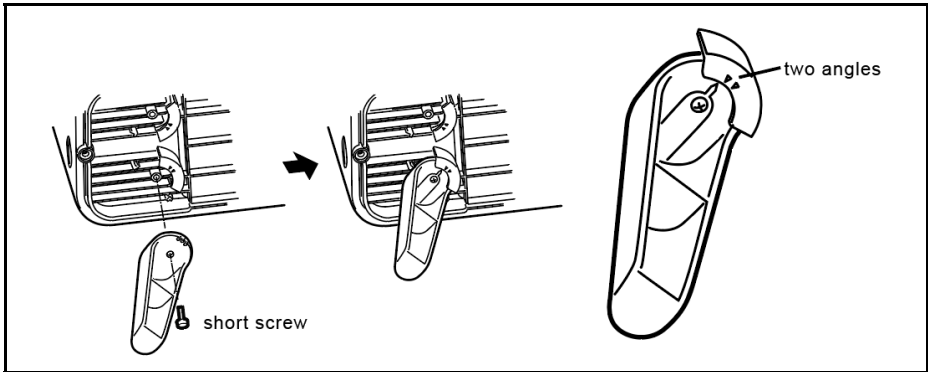

1. Place the dehumidifier flat on a stable surface.
2. Align the round hole of the leg with the screw post.
3. Adjust to the desired installation angle; two angles are available to choose from.
4. Secure the leg with a M4x12 screw.
5. Assemble the remaining three legs in the same manner.

CLEANING, MAINTENANCE & STORING THE APPLIANCE

STEP 1 - CLEANING YOUR FILTER

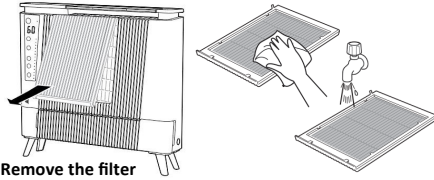

Remove the filter

1. Turn off and leave for 5 minutes, then unplug the dehumidifier. Remove the filter.
2. Clean the filter with a brush, vacuum cleaner or wash with lukewarm water.
3. Reinsert the filter back into position.

Tip: Clean your filter every 2 weeks to keep your air clean and prolong the life of your dehumidifier. The frequency will depend on conditions of operation. Filter must be cleaned every 2 weeks to avoid overheating and malfunction.

Note: If the filter is covered with dust, the airflow and the performance of the dehumidifier will be affected and it may void the warranty.

STEP 2 - REPLACING YOUR FILTER

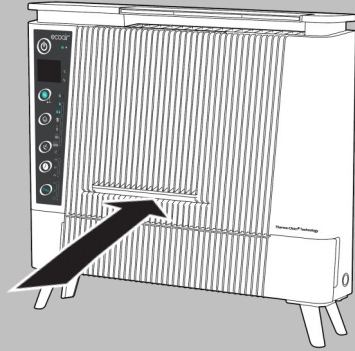

It is recommended that the pre filter is replaced every 6 months for optimal performance and hygiene standards. To purchase a replacement filter or optional charcoal filter, please visit: www.ecoair.org

STEP 3 - CLEANING YOUR DEHUMIDIFIER

1. Turn off and leave for 5 minutes, then unplug the dehumidifier.

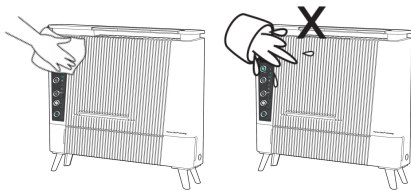

2. Clean the surface with a soft damp cloth.
3. Dry thoroughly with a towel after cleaning.
4. For cleaning tank, see Emptying the Water Tank section (page 10).

Caution:

- Do not wash the unit or immerse in water.
- Do not let water drip into the air inlet or outlet.
- When cleaning the water tank, take caution to avoid damaging the float.

STEP 4 - STORING YOUR DEHUMIDIFIER

1. Turn off the dehumidifier, wait 30 minutes and unplug the dehumidifier from the power socket.
2. Leave the dehumidifier to drain for approximately one day. Clean and dry the water tank.
3. Clean the filter and the dehumidifier. Cover the dehumidifier to prevent it from gathering dust. Store upright in a cool dry place.
4. Do not expose to direct sunlight.

TROUBLESHOOTING

CHECK THE FOLLOWING POINTS BEFORE CONTACTING TECHNICAL SUPPORT.

PROBLEM	REASON	SOLUTION
No Power	Dehumidifier is not plugged in or there is no power supply	Plug into a main socket and switch ON. If necessary, try another main socket.
 Water Full / Check Light On	Filter clogged *	Check and clean or replace the filter
	The air inlet or outlet is blocked or covered	Remove obstructions
	Water tank is full or installed incorrectly	Empty water tank or re-install correctly
	"Er" message is blinking to signify a blockage in the air inlet or outlet or other abnormality.	The filter is dirty or clogged. Please clean or replace.
	The unit is emitting an unusual odor.	This is a normal and harmless by product of the zeolite desiccant material. The smell occurs because the zeolite absorbs odors from cigarettes, cosmetics, hair sprays, building materials and new furniture, and when heated discharges the odor into the room. The smell will dissipate when heated off the desiccant where Dust can build up internally inside the dehumidifier, causing obstruction to airflow and overheating. This will cause malfunction. Common symptoms are Check Light On, Water Leaking and Not Collecting Water (see details above). When this happens, you will need to request a service at our Service Centre. * Clean the filter regularly (recommended every 2 weeks) to avoid malfunction.
	Ambient temperature or humidity level out of range	Check that the temperature and humidity are within the operating ranges, use a hygrometer to measure (available to purchase at ecoair.org)
Water float out of position or broken	Restore position or replace with the water tank	
* Noisy	Water tank or filter fitted incorrectly	Check and refit the water tank or filter Check unit is on an even level surface
	Foreign object fallen through the vent into the dehumidifier	Contact support@ecoairgb.com for AdHoc Service
	Dehumidifier placed on an uneven surface	Place on an even surface. If necessary test with a spirit level

In the unlikely event of a problem with your product, please refer in the first instance to:

ECOAIR TECHNICAL SUPPORT : www.ecoair.org/support
PRODUCT MANUAL GO TO : ecoair.org/pages/help-and-support

TROUBLESHOOTING

CHECK THE FOLLOWING POINTS BEFORE CONTACTING TECHNICAL SUPPORT.

PROBLEM	REASON	SOLUTION
Not Collecting Water	Set humidity is reached	Your target humidity settings have been reached. This is normal.
	Room is very cold or very dry for the current settings	Readjust the humidity setting or increase the room temperature
	Filter dusty *	Clean the air filter or replace it
	Dehumidifier set up incorrectly	Refer to manual for important safeguard, Installation and operation.
	Room Temperature is too hot	Turn off the dehumidifier. Decrease the room temperature and check the operating temperature range, room size
Water Leaking	Dehumidifier on uneven surface or water tank fitted incorrectly	Ensure the dehumidifier is on a flat, even surface, use a spirit level to check, remove tank and replace correctly
	Filter clogged *	Clean or replace filter *
	Removing the tank whilst the dehumidifier is running	Always unplug the dehumidifier and allow 30 minutes before removing the tank
	Moving or tilting the dehumidifier whilst water residue remains inside the dehumidifier	Always turn off the dehumidifier, wait 30 mins, empty the tank and reinsert the tank before moving the dehumidifier.
	Damaged water tank	Remove the water tank, fill with water and place on a hard even surface to test for leakage
	The continuous drainage is clogged or loose	Check the continuous drainage hose and its connection
	The unit is mounted on wall and it's not level with the wall	Fix the unit level check wall is true with spirit level
	The bung is missing from the water tank	Refix the bung to the water tank
	The float in the tank is improperly position	Position the float correctly in the tank
	Removing the tank whilst dehumidifier is setup on continuous drainage	Check the continuous drainage hose and its connection