

## Use & Care Guide

# FreshHome

## PlasmaWave™ True HEPA Air Cleaner

Model : WACP150, WACP300, WACP450

## Winix Air Purifiers



• WACP150

• WACP300

• WACP450

Made in Korea

### Contact Us

WINIX USA 120 Prairie lake Road. Unit E East Dundee, Illinois 60118  
www.winixinc.com E-Mail : info@winixinc.com  
Tel : +1.847.551.9900

WINIX Europe 14 cours de l'Intendance, 33000 Bordeaux, France  
www.winixeu.com E-Mail : info@winixeu.com  
Tel : +33.556.448.572

For more information  
Please download WINIX app  
(Android / I Phone)

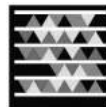

Aug. 2012

### CAUTION:

Read and follow all safety rules and instructions  
before operating this equipment

Read and follow all safety rules and instructions before operating this equipment.  
Please keep this manual for future reference.

## TABLE OF CONTENTS

Warranty .....	2
Package Contents .....	2
Instructions .....	3
Safety Instructions .....	7
Product Specifications .....	8
Air Cleaner Features .....	9
Air Cleaner Set-Up .....	10
Control Panel .....	11
Operations .....	11
Filter Replacement .....	12
Remote Control .....	14
Troubleshooting .....	15

## LIMITED PRODUCT WARRANTY

### WINIX FRESHOME™ AIR CLEANERS LIMITED WARRANTY

Limited Warranty: Winix warrants the parts of the machine to be free of defects in material and workmanship and provides service and support for one (1) year from the date of purchase by the original consumer for model WACP150, and (3) years from the date of purchase by the consumer for models WACP300 and WACP450.

If any part is found to be defective during the warranty period, your sole and exclusive remedy will be repair or replacement, at Winix's option and expense, of the defective part.

This warranty does not apply in cases of abuse, mishandling, failure to comply with product usage standards, operation using an improper power supply (other than listed on the label), or unauthorized repair.

Winix reserves the right to charge the consumers for any additional costs incurred by Winix to provide parts or services outside of the country where the air purifier is initially sold by an authorized reseller. This warranty does not include the air cleaner's replaceable filters, this is an expendable part that can wear out from normal use before one the warranty expires.

ANY IMPLIED WARRANTY, INCLUDING THAT OF MERCHANTABILITY OR FITNESS FOR A PARTICULAR PURPOSE, IS HEREBY LIMITED IN DURATION TO THE APPROPRIATE WARRANTY PERIOD SET FORTH ABOVE.

In no event shall Winix be liable for any consequential or incidental damages attributable to this product.

This warranty gives you specific legal rights. The duration, terms, and conditions of this warranty are valid worldwide, except where different limitations, restrictions, or conditions may be required by local law.

For more details or to obtain service under this warranty, please contact your dealer.

## PACKAGE CONTENTS

### Models WACP300 AND WACP450

- Winix Air Purifier (Qty.1)
- Carbon Pre-Filters (Qty.4)
- True HEPA Filter (Qty.1)
- Use & Care Guide (Qty.1)
- Remote control (Qty.1)
- 3V Lithium Battery (CR2025 installed in remote)

### Models WACP150

- Winix Air Purifier (Qty.1)
- Carbon Pre-Filters (Qty.4)
- True HEPA Filter (Qty.1)
- Use & Care Guide (Qty.1)

# INSTRUCTIONS

## WARNING:SAFETY INSTRUCTIONS

WARNING / NOTICE	DIRECTION
<p><b>⚠ WARNING</b></p> <p>Follow these instructions to avoid any risk of personal injury, property damage, electrical shocks or fire hazards.</p>	<p><b>⊘ PROHIBITED</b></p> <p><b>⊘ DO NOT DISASSEMBLE</b></p>
<p><b>⚠ NOTICE</b></p> <p>Failure to follow the safety instructions can lead to personal injury or property damage.</p>	<p><b>! Must Follow</b></p> <p><b>⚡ Ground connection protecting from electrical shock</b></p>

### ⚠ Warning ▶ Power

**DO** connect the power cord to only proper power outlet with a ground connection.

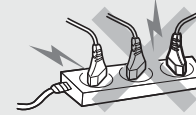

**DO** unplug air cleaner when not in use to save energy consumption.

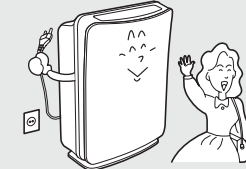

**DON'T** plug power cord into loose or damaged electrical outlet.

(Can lead to overheating or electrical shock.)

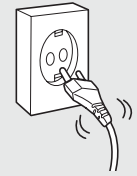

### ⚠ Warning ▶ Power Cord

**DON'T** unplug the unit by pulling on its power cord.

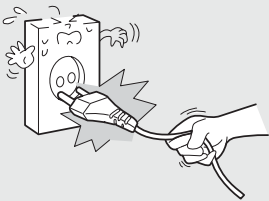

**DON'T** bend or place heavy object on the power cord.

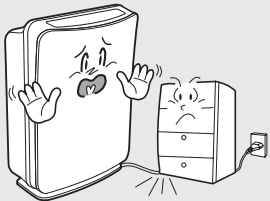

**DON'T** touch the plug with wet hands.

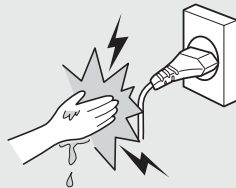

**DON'T** replace or modify the power cord.

If the power cord/plug is damaged, it must be replaced by the manufacturer or a qualified technician.

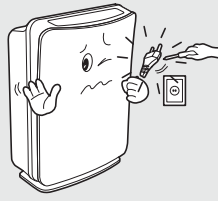

### ⚠ Warning ▶ Operation

**DON'T** attempt to repair, alter or disassemble the air cleaner.



**DON'T** operate air cleaner on an uneven surface.

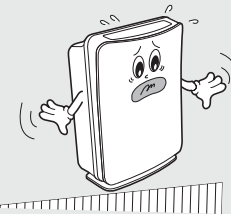

**DON'T** operate the air cleaner if standing water is present.

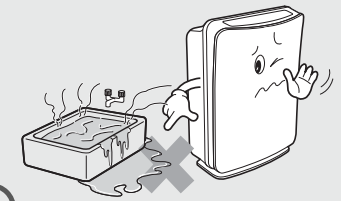

**DON'T** operate air cleaner near flammable materials.



**! Note** ▶ Power

**DON'T** disconnect the power cord during operation.

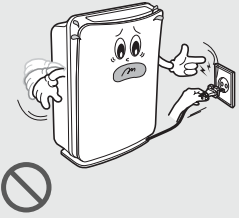

**DON'T** unplug the power cord before air cleaner has cooled down.

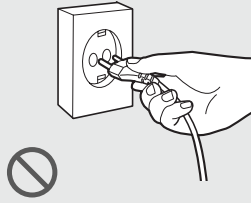

**DO** unplug the unit and contact your service dealer if any irregular noise or smoke occurs.

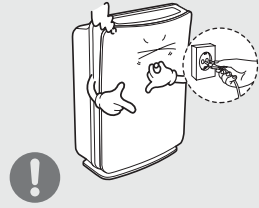

**! Note** ▶ Operation

**DON'T** insert ANYTHING into the air inlet or outlet.

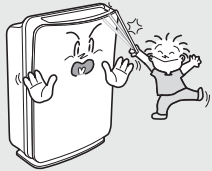

**DON'T** place hands or any body parts near the air outlet during operation.



**DON'T** place the air cleaner near heater.

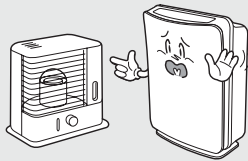

**DON'T** place the air cleaner near curtains or other materials that can block the vents of the unit.

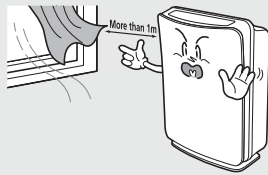

**! Note** ▶ Operation

**DON'T** strike or drop the air cleaner.



**DON'T** fill the air cleaner with hot water.

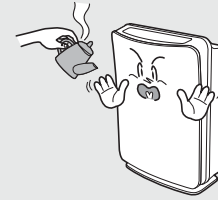

**DON'T** use flammable material (such as benzene or alcohol) to clean the air cleaner.

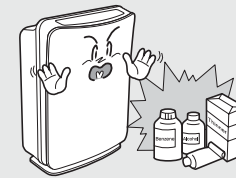

**DON'T** place clothes and towels on top of air cleaner while operating.



**DON'T** allow children to play on or near the air cleaner.

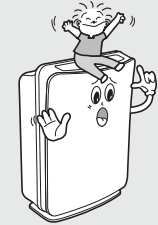

**DON'T** spray flammable liquids or gases into the unit.

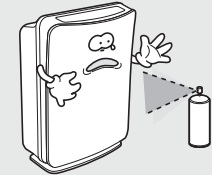

**DON'T** install the unit under direct light.

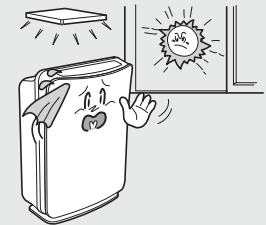

**DON'T** spray liquids directly into air cleaner during cleaning.

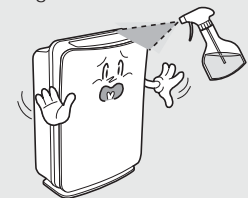

## ⚠ SAFETY INSTRUCTIONS

Thank you for purchasing a Winix air cleaner. Please read this manual carefully before using. This product is for household use only.

### IMPORTANT CAUTIONS FOR USING YOUR AIR CLEANER

**WARNING:** Follow the instructions in this manual to reduce the risk of electric shock, short circuit, and/or fire:

- Do not repair or modify the unit unless specifically recommended in this manual. All other repairs should be completed by a qualified technician.
- The plug for this unit is polarized with one blade wider than the other. Do not force the plug into an electrical outlet. Do not alter the plug in any way. If the plug does not fit into the outlet, reverse the plug. If it still does not fit, contact a qualified technician to install a proper outlet.
- Do not use if the power cord or plug is damaged or the connection to the wall outlet is loose.
- Use AC 120V only.
- Do not damage, break, forcefully bend, pull, twist, bundle, coat, pinch, or place heavy objects on the power cord.
- Periodically remove dust from the power plug. This will reduce the risk of shock due to humidity build up.
- If the power plug is damaged, it must be replaced by the manufacturer or a qualified technician
- Remove the power plug from the outlet before cleaning the unit. When removing the power plug, grasp by holding the plug itself, never hold by the cord.
- Remove the power plug from the outlet when not in use.
- Do not handle the power plug with wet hands.
- Do not operate the unit when using indoor smoke-generating insecticides.
- Do not clean unit with benzene or paint thinner. Do not spray insecticides on the unit.
- Do not use the unit where it is humid or where the unit may become wet, such as in a bathroom.
- Do not insert fingers or foreign objects into the air intake or outlet.
- Do not use the unit near flammable gases. Do not use near cigarettes, incense, or other spark-creating items.
- Unit will not remove carbon monoxide emitted from heating appliances or other sources.

### IMPORTANT PRECAUTIONS FOR USING YOUR AIR CLEANER

- Do not block the intake or outlet vents.
- Do not use near hot objects, such as a stove.
- Do not use where the unit may come into contact with steam.
- Do not use the unit on its side.
- Keep away from products that generate oily residue, such as a deep fryer.
- Do not use detergent to clean the unit.
- Do not operate without a filter.
- Do not wash and reuse the True HEPA Filter or the Carbon Pre-Filter.
- Hold the handle on the back of the unit to transport.
- Do not hold by the front panel.

## PRODUCT SPECIFICATIONS

Model	WACP150	WACP300	WACP450
Room Size	150 sq. ft.	300 sq. ft.	450 sq. ft.
Power Supply	AC 120V/60(Hz)	AC 120V/60(Hz)	AC 120V/60(Hz)
Power Rate	Low 4W, Turbo 40W	Low 4W, Turbo 60W	Low 11W, Turbo 110W
Fan Speeds	4 Speeds	4 Speeds	4 Speeds
Display	Digital	Digital	Digital
Control Type	Auto/Manual	Auto/Manual	Auto/Manual
Remote Control	No	Yes	Yes
Air Quality Sensor	Yes	Yes	Yes
Light Sensor	Yes	Yes	Yes
AHAM Certified	Yes	Yes	Yes
UL Listed	Yes	Yes	Yes
Energy Star Qualified	Yes	Yes	Yes
Check Filter Indicator	Yes	Yes	Yes
Cleaning System			
- Carbon Pre-Filter	Yes	Yes	Yes
- True HEPA Filter	Yes	Yes	Yes
- PlasmaWave™	Yes	Yes	Yes
CADR	Smoke/Dust/Pollen 98/98/103	Smoke/Dust/Pollen 197/197/214	Smoke/Dust/Pollen 291/298/343
Unit Size (inches, L×W×H)	8.27×18.50×13.78	8.66×21.65×16.30	10.24×25.59×17.32
Unit Weight (lbs)	11.15	13.95	19.40

**Warning:** Change or modifications to this unit not expressly approved by the party responsible for compliance could void the user's authority to operate the equipment.

**NOTE:** This equipment has been tested and found to comply with the limits for a Class B digital device, pursuant to Part 15 of the FCC Rules. These limits are designed to provide reasonable protection against harmful interference in a residential installation. This equipment generates, uses and can radiate radio frequency energy and, if not installed and used in accordance with the instructions, may cause harmful interference to radio communications. However, there is no guarantee that interference will not occur in a particular installation. If this equipment does cause harmful interference to radio or television reception, which can be determined by turning the equipment off and on, the user is encouraged to try to correct the interference by one or more of the following measures:

- Reorient or relocate the receiving antenna.
- Increase the separation between the equipment and receiver.
- Connect the equipment into an outlet on a circuit different from that to which the receiver is connected.
- Consult the dealer or an experienced radio/TV technician for help.

## AIR CLEANER FEATURES

**CAUTION:** Fully assemble air filter before using (See Air Cleaner Set-Up on following page).  
**Note:** Features vary widely according to model.

### • Quiet Operation

This Winix air cleaner has a four-speed fan with quiet operation that is ideal for nighttime.

### • Air Quality Sensor

This Winix air cleaner has an AIR QUALITY sensor that detects the presence of various pollutants in the air. The unit automatically increases fan speed to clean more air volume and remove the impurities quickly.

### • Light Sensor

The built-in light sensor detects when the room is dark and automatically dims the lights of the control panel and lowers the fan speed for quiet and energy-efficient operation. Once the room is dim, and not allow the fan to increase speed despite what the AIR QUALITY sensor detects.

### • Multi-Stage Cleaning

The air passes through multiple stages of cleaning before returning to the room.

### • PlasmaWave™ Technology

PlasmaWave™ breaks apart airborne pollutants at the molecular level.

### • Carbon Pre-Filter

The Carbon Pre-Filter collects large particles, such as dust, pet hair, and lint. It absorbs odor-causing gases, such as those caused by cigarette smoke, organic decay, and cooking, effectively reduce the development of bacteria and fungi. For best performance, replace every three months.



### • True HEPA Filter

Captures 99.99% of particles and impurities as small as 0.3 microns, including smoke, dust, pollen, and other allergens. Replace when the CHECK FILTER indicator light turns on.



### Advanced PlasmaWave™ Technology

PlasmaWave™ breaks apart airborne pollutants at the molecular level.

In a fraction of a second, PlasmaWave™ combines with naturally occurring water molecules in the air (H<sub>2</sub>O) to create billions of Hydroxyl Radical molecules (OH).

OH is an unstable molecule that seek equilibrium by stealing hydrogen atoms from adjacent molecules containing hydrogen (the pollutants), thereby reforming them into harmless molecules of water, carbon dioxide, and other acceptable molecules.

The result is a measurable reduction of pollutants after the air passes through the Plasma Generator (PlasmaWave™).

By reforming molecules, PlasmaWave™ technology can reduce odors, as well as VOCs (chemical vapors). It is also effective at reducing airborne.

The PlasmaWave™ technology is harmless and the OH molecule only lives for a nanosecond while it reforms surrounding molecules. Most importantly-unlike old style ion technology-PlasmaWave™ does not produce high levels of ozone as a by-product.

When combined with a fan-and-filter air cleaning system, PlasmaWave™ offers an effective and efficient way of cleaning the air of unwanted pollutants including dust, smoke, and pollen, as well as VOCs, allergens, and odors.

## AIR CLEANER SET-UP

### Set-Up Procedure

1. Remove protective film from the control panel.
2. Remove the front panel by pulling gently from the lower portion of the panel. Do not force; the panel should remove easily.
3. Remove the plastic frame from the unit.
4. Remove the True HEPA Filter and remove the plastic wrapper from the filter.
5. Install the True HEPA Filter with the arrow showing "air flow" pointing in toward the back of the air cleaner; the white tabs at the top and bottom of the HEPA filter will point out to the front of the unit.
6. Open the resealable plastic bag containing the Carbon Pre-Filters and remove one filter. Reseal the plastic bag to maintain the freshness of the remaining filter.
7. Install the Carbon Pre-Filter onto the plastic frame by pushing against all "hook and loop" squares on the back of the frame. (Diag. 7A)
8. Install the plastic frame by inserting tabs up into the air cleaner and gently pushing in at the bottom tab until the frame fits into place snugly.
9. Replace the front panel by hooking the panel on the top of the unit. Swing the panel in by pushing gently on each side of the unit and then lock it into place.
10. Plug the power cord into a wall outlet.
11. Press and hold the POWER button until a short "beep" sounds.
12. The air cleaner will take 304 minutes to calibrate the AIR QUALITY sensor. During this time the sensor lights will flash on and off. Once the sensor has calibrated, the lights will begin in AUTO mode.
13. Remove tab from remote control (WACP300 / WACP450 only.)

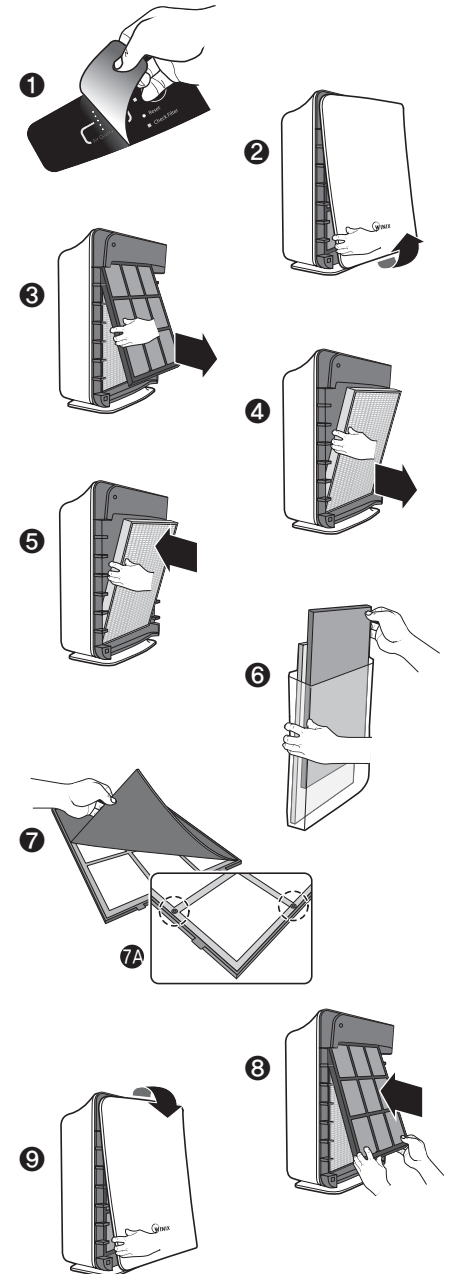

**Note:** For best results and to maximize air flow:

- Place unit at least 2 feet away from the wall.
- Place the unit away from drafty areas, as the sensors may not react accurately.
- Do not place near curtains, furniture, or other items that might inhibit air flow.
- Place the unit on a stable surface.

## CONTROL PANEL

- A. AIR QUALITY SENSOR:** Automatically monitors the air quality level and adjusts fan speed accordingly in Auto.
- B. AUTO:** Changes the mode setting to AUTO.
- C. RESET:** Resets the CHECK FILTER indicator light.
- D. CHECK FILTER:** Signals when to replace filters.
- E. PlasmaWave™:** Shows that PlasmaWave™ Technology is active.
- F. AIR QUALITY:** Green, yellow, and red lights indicate the quality of the air.
- G. Turbo / High / Med / Quiet:** Shows current fan speed setting.
- H. SPEED:** adjusts fan speed to QUIET, MED, HIGH or TURBO.
- I. ⏻:** Turns the unit On and Off.
- J. LIGHT SENSOR:** dims the control panel lights and sets the fan speed to QUIET when the room is dark.

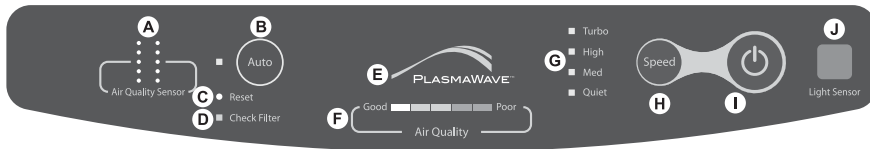

## OPERATIONS

**AUTOMATIC OPERATION:** The unit is set to automatic operation when it is first turned on. The air purifier will automatically sense the amount of impurities in the air, and adjust the fan speed to keep your air purified.

**MANUAL OPERATION:** After you turn on the unit, you can switch to manual operation by using the SPEED button. To go back to the automatic operation press AUTO.

**QUIET, MED OR HIGH:** These levels are recommended for standard daytime use. HIGH will activate automatically when sensors detect poor air quality in AUTOMATIC OPERATIONS. Use the SPEED button to select the required level.

**TURBO:** This is the highest fan speed. It can be activated manually for maximum air purification by pushing the SPEED button several times.

## FILTER REPLACEMENT

### Filter Replacement

- There are two separate filters: True HEPA Filter and Carbon Pre-Filter.
- The CHECK FILTER indicator will signal when to replace the True HEPA Filter. The replacement period will vary depending on the hours of usage, air quality, and location of the unit. However, in most cases of normal use the filter will need to be replaced annually.
- Change the True HEPA Filter when the CHECK FILTER indicator is on.
- For best performance, change the Carbon Pre-Filter every three months. This filter should be disposed of when changed.

**CAUTION:** Turn off the air cleaner and unplug the electrical cord before performing any maintenance.

### Carbon Pre-Filter Replacement

1. Turn off the air cleaner and unplug the electrical cord.
2. Remove the front panel by pulling gently from the lower portion of the panel. Do not force, the panel should remove easily.
3. Remove the Carbon Pre-Filter and plastic frame by gently pulling out from the bottom and down from the top.
4. Remove the Carbon Pre-Filter from the plastic frame and dispose of it.
5. Remove a replacement Carbon Pre-Filter from the resealable plastic bag and reseal to maintain the freshness of the remaining filter.
6. Install the Carbon Pre-Filter onto the plastic frame by pushing against six "hook and loop" squares on the back of the frame. (DIAG. 6A)
7. Install the plastic frame by inserting tabs up into the air cleaner and gently pushing in at the bottom tab until the frame fits into place snugly.
8. Replace the front panel by hooking the panel on the top of the unit. Swing the panel in by pushing gently on each side of the unit and then lock it into place.
9. Plug in air cleaner and press POWER button until short "beep" sounds.

**CAUTION:** Do not wash and reuse the True HEPA Filter or the Carbon Pre-Filter as they will not work effectively.

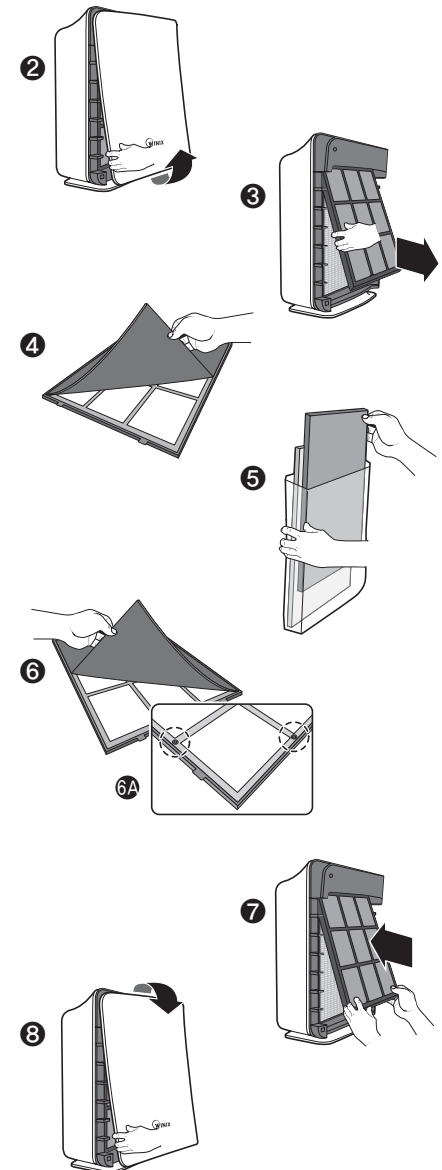

**CAUTION:** Turn off the air cleaner and unplug the electrical cord before performing any maintenance.

### True HEPA Filter Replacement

1. Turn off the air cleaner and unplug the electrical cord.
2. Remove the front panel by pulling gently from the lower portion of the panel. Do not force, the panel should remove easily.
3. Remove the Carbon Pre-Filter and plastic frame by gently pulling out from the bottom and down from the top.
4. Remove the True HEPA Filter and dispose of it.
5. Remove the plastic wrap from the new True HEPA Filter and insert it with the arrow showing "air flow" pointing in toward the back of the top and bottom of the True HEPA Filter will point out to the front of the unit.
6. Reinstall the plastic frame and Carbon Pre-Filter by inserting tabs up into the air cleaner and gently pushing in at the bottom tab until the frame fits into place snugly.
7. Replace the front panel by hooking the panel on the top of the unit. Swing the panel in by pushing gently on each side of the unit and then lock it into place.
8. Plug in air cleaner and press POWER button until short "beep" sounds.
9. Press the RESET FILTER button by gently inserting a paperclip into the RESET FILTER hole on the control panel. The light will flash 5 times before a "beep" sounds to indicate the filter has been reset. See figure C on page 8 or Diag. 9 to the right.

The air cleaner will take 3-4 minutes to calibrate the AIR QUALITY sensor. During this time the sensor lights will flash on and off. Once the sensor has calibrated, the lights will stop flashing and the unit will begin in AUTO mode.

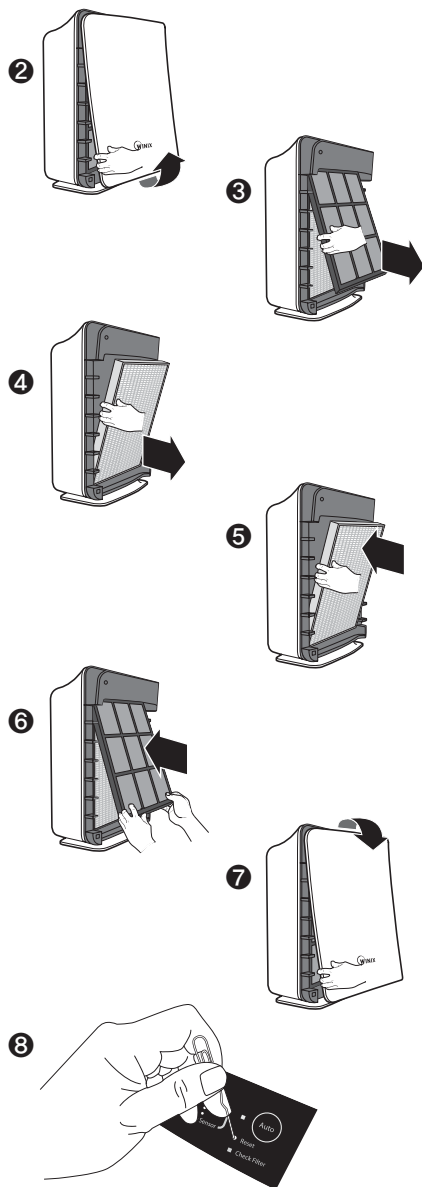

## REMOTE CONTROL

### BATTERY REPLACEMENT

1. Squeeze tabs of battery cover and at the same time pull cover out of remote.
2. Insert battery as shown and close battery cover.
3. Always use 3V lithium battery CR2025 into the remote control.

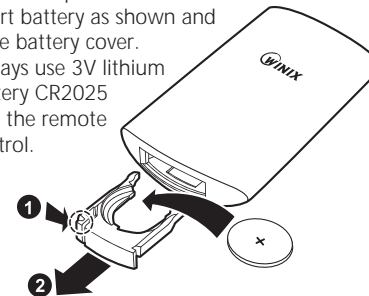

**CRADLE:** The remote control has a separate wall-mountable storage cradle that can be conveniently attached to any wall using a screw.

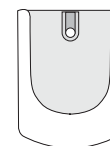

### BATTERY USE

- Always use 3V lithium battery CR2025 into the remote control.
- Incorrect battery usage may cause battery fluid leakage and/or damage.
- When not using remote control for an extended period, remove the battery.
- Avoid dropping or damaging the remote control.

### PROPER OPERATING CONDITIONS

- Operate the remote control facing the air cleaner.
- Operate within 20 feet of the air cleaner.

### IMPROPER OPERATING CONDITIONS

- Any location where there is inverter lighting equipment or electronic spontaneous lighting equipment.
- When objects or furniture are located between the remote and the air cleaner.
- When air cleaner unit is located in direct sunlight, as sunlight may interfere with the infrared sensor.
- In areas where fluorescent lighting is flickering due to worn-out bulbs.
- Keep remote control away from direct sunlight or heaters.

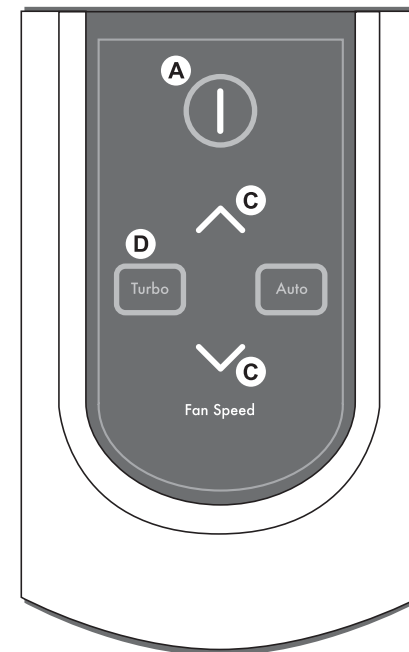

**A. POWER:** Use the power button to turn the power on and off. A short "beep" will sound when the unit turns on or off.

**B. AUTO:** Use the Auto button to engage the unit into Auto mode.

**C. FAN SPEED:** By pressing up or down, the unit will change fan speeds and enter into manual mode.

**D. TURBO:** Use this button to switch from automatic operation and begin the maximum amount of room air cleaning and air movement and will remain in Turbo speed until changed into Auto or Manual mode.



## TROUBLESHOOTING

### Before You call

#### Solutions to Common Problems

Before you call for service, review the list below. This list covers problems that are not the result of defective materials or workmanship.

OCCURRENCE	POSSIBLE CAUSE / SOLUTION
The remote control dose not work.	<ul style="list-style-type: none"> <li>• Make sure the remote control battery is inserted correctly. dose not work.</li> <li>• Replace a worn-out battery.</li> <li>• Make sure that the remote control has a clear line of sight to the air cleaner.</li> </ul>
The unit has stopped removing odors effectively, or seems to be emitting an odor.	<ul style="list-style-type: none"> <li>• Make sure the AIR QUALITY sensor is not blocked or clogged.</li> <li>• Move the unit closer to the offending odors.</li> <li>• Replace the filters as they may have reached their capacity to absorb pollutants. You may need to replace filters more frequently.</li> </ul>
The AIR QUALITY LEVEL indicator is orange or red, but the air seems clean.	Clear the AIR QUALITY sensor with a vacuum cleaner as it may be blocked or clogged.
Unit interferes with radio or television reception.	<p>Because this unit radiates radio frequency energy, try one or more of the following suggestions:</p> <ul style="list-style-type: none"> <li>• Reorient or relocate the receiving antenna.</li> <li>• Increase the distance between the equipment and the air cleaner.</li> <li>• Connect the air cleaner to an outlet on a circuit different from that to which the equipment is connected.</li> <li>• Consult an experienced television/radio technician.</li> </ul>
The CHECK FILTER indicator remains lit after replacing the True HEPA Filter.	Press the RESET FILTER button by gently inserting a paper-clip into the RESET FILTER button hole. Hold for 3-5 seconds until a "beep" sounds to indicate the unit has been reset.
The unit does not remove smoke and odors in the air.	<ul style="list-style-type: none"> <li>• Make sure the sensor is not blocked or clogged.</li> <li>- The filters may need replacement</li> </ul>
The unit seems to produce odors.	<ul style="list-style-type: none"> <li>• Move the unit closer to the offending odors.</li> <li>- Replace the carbon filter</li> <li>- Replace the HEPA filter</li> </ul>

OCCURRENCE	POSSIBLE CAUSE / SOLUTION
The air quality light is green, but there is still dust/odor in the air.	<ul style="list-style-type: none"> <li>• Replace the filters as needed.</li> </ul>
The air quality light is yellow or red, but the air seems clean.	<ul style="list-style-type: none"> <li>• Clear the sensor with a vacuum cleaner, as it may be blocked or clogged.</li> <li>- Sometimes a compressed can of air may unplug the dust in the sensor.</li> </ul>
Unit makes a ticking sound.	<ul style="list-style-type: none"> <li>• This is caused by the PlasmaWave™ technology, it may come and go depending on the environment, but as long as the PlasmaWave™ light is on, the function is working.</li> </ul>
Unit interferes with radio or television reception.	<ul style="list-style-type: none"> <li>• Because this unit radiates radio frequency energy, we suggest you try one or more of the following: <ul style="list-style-type: none"> <li>- For better reception, adjust the television/radio antenna.</li> <li>- Move the unit away from the affected television/radio.</li> <li>- Plug the unit power cord into an outlet different from the television/radio power cord.</li> </ul> </li> </ul>
The FILTER REPLACEMENT indicator remains lit after replacing the True HEPA and/or Carbon Filter.	<ul style="list-style-type: none"> <li>• Press the reset filter button by gently inserting a paperclip end into the RESET FILTER opening,. Hold for 3-5 seconds until you hear a "beep" and light turns off.</li> </ul>
The Remote Control Does Not Work	<ul style="list-style-type: none"> <li>- Make sure the battery is installed properly.</li> <li>- Make sure the battery may not need replacing due to being worn out.</li> <li>- Make sure the remote has a clear line of sight to the air cleaner.</li> </ul>
There is still some dust you can see in the air or on my furniture	<ul style="list-style-type: none"> <li>- The unit will capture most dust and particles, however with opening doors, windows, central HVAC etc... there may still be some level of dust that you can see.</li> </ul>
There is nothing holding the filters in place	<ul style="list-style-type: none"> <li>- The filters are meant to rest inside the unit. Once the unit is turned on, the force of air pulled through the machine will create a tight seal of the filters.</li> </ul>
I can hear revving of the fan motor	<ul style="list-style-type: none"> <li>- This is normal, especially at night when all environmental sounds are quiet, you may hear the motor running in repetition.</li> </ul>

OCCURRENCE	POSSIBLE CAUSE / SOLUTION
The unit is running on high all the time.	Clear the sensor with a vacuum cleaner, as it may be blocked or clogged. - Sometimes a compressed can of air may unclog the dust in the sensor.
Can I wash my filter?	NO - the filters that come with the unit will fall apart and be ruined if water is run through them.
Can I vacuum my filter?	NO - vacuuming will only spread the dust back into the air. If you think the filter is too dirty, it may be time to replace.
There is an odor coming from the unit and I just opened it.	The unit has been concealed in a tightly wrapped package of corrugated cardboard and plastic. Because this has a fan and pulls air through it, it may give off some "new" odors. Depending on sensitivity, this should wear off in several days or perhaps a week depending on how much it is used.
I am not sure what filter to buy?	Go to <a href="http://www.winixinc.com">www.winixinc.com</a> to see which filter options are available for your unit by reviewing the reference chart.
Will this clean a bigger area than what it is rated for?	CADR ratings are provided from a controlled testing environment, if that environment changes, it can affect the performance. However if you have a slightly larger room than what the CADR rating is, it will still help improve the air, but may take a bit longer to do so.
Where should I place the unit?	At least 2 feet away from the wall to allow proper circulation around the unit. If there are doors or narrow hallways it may reduce the airflow to the air cleaner, but will eventually circulate near the machine.
Can I turn off the sleep mode?	No, however you can manually push what fan speed you prefer which will stay at that speed until you change it.